



PROJECT _____

TYPE _____

NOTES _____

QUANTITY _____

DATE _____



Cylindrical ceiling surface mounted downlight made from die-cast aluminium; surface White Matt; powder coated; matt texture; RAL 9010; with COB (Chip on Board) technology for maximum efficiency; phase-cut dim; light colour 2700 K; ≤ 3 SDCM (initial MacAdam); CRI ≥ 90 ; 220 - 240 V; degree of protection IP20; Class 1; UGR ≤ 13 ; VDU compatible workplace luminaire according to DIN EN 12464-1; luminance above 65° ≤ 1500 cd/m²; optional single inner cover available; light source replaceable by Wever & Ducré or by a professional with explicit authorization;

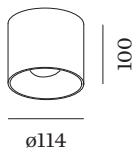

LUMINAIRE

Ceiling _____
 Surface _____
 White Matt _____
 RAL 9010 ^a _____
 IP20 _____
 Interior _____
 605 lm _____

LED Module

2700 K _____
 CRI ≥ 90 _____
 L70 / 50000h _____
 ≤ 3 SDCM (initial MacAdam) _____
 730 lm _____
 91 lm/W ^b _____

Optical

Medium (standard) _____
 beam angle 21° _____
 CIE flux code: 93 99 100 100 _____
 100 _____

Electrical

phase-cut dim _____
 220 - 240 V _____
 system 8.1 W _____
 Class I _____
 Standard _____

Physical

diameter 114 mm _____
 height 100 mm _____
 0.7 kg _____

datasheet.quicksum.material

Aluminium _____

^a Colour may deviate slightly due to production conditions
^b Without electrical and optical losses

LIGHT DISTRIBUTION

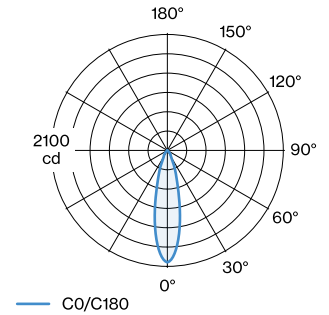



Maintenance Factor

Operating Time [h]	10.000	20.000	30.000	40.000	50.000
LLMF	0	0	0	0	0
LSF	1	1	1	1	1

MF	$LMF \times RSMF \times LLMF \times LSF$	RSMF ^a	Room Surface Maintenance Factor
MF	Maintenance Factor	LLMF	Lamp Lumens Maintenance Factor
LMF ^a	Luminaire Maintenance Factor	LSF	Lamp Survival Factor

^aAccording to "CIE 97, Maintenance of indoor electric lighting systems", 2005, ISBN 3-900-734-34-8. The values must be determined by the planner.

OPTICAL ACCESSORIES

Single Inner Cover

Type	Colour	Voltage	Ø·H (MM)	Item number
RAY max. 10W	Black		67·54	911041B1
RAY max. 10W	Gold		67·54	911041G1
RAY max. 10W	Champagne		67·54	911041M1
RAY max. 10W	White		67·54	911041W1