

# INVISIBLE CEILING SUSPENSION SYSTEM

INSTALLATION INSTRUCTIONS | JULY 2020

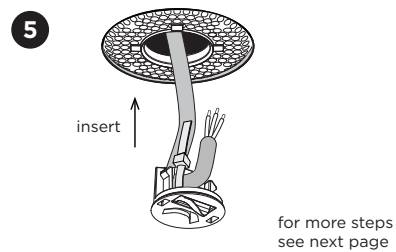

## DIMENSIONS

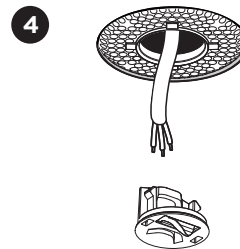
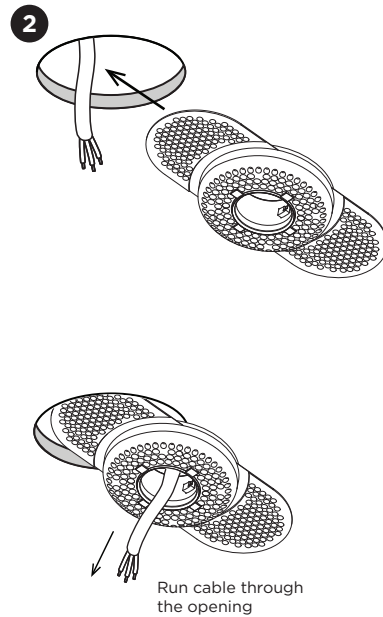
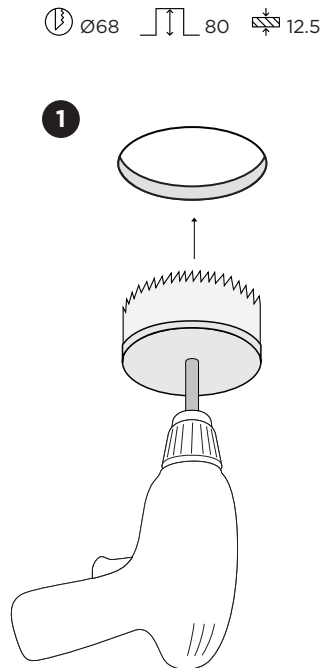
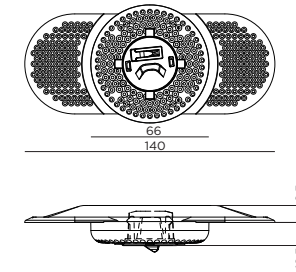

## MOUNTING INSTRUCTION

- 1** Drill a hole with diameter **68mm** in the ceiling by using a hole saw.
- 2** Run cable through opening and insert plaster insert.
- 3** Fix to the ceiling by screwing from below.

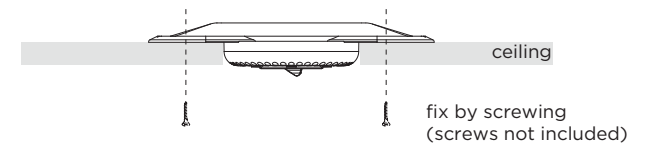

- 4** Fasten the mains cable to the protection cover.
- 5** Click the protective cover into the opening by positioning the lids from the cover with the lids from the plaster insert

# INVISIBLE CEILING SUSPENSION SYSTEM

INSTALLATION INSTRUCTIONS | JULY 2020

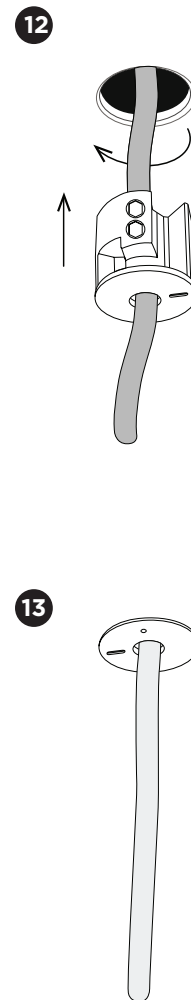
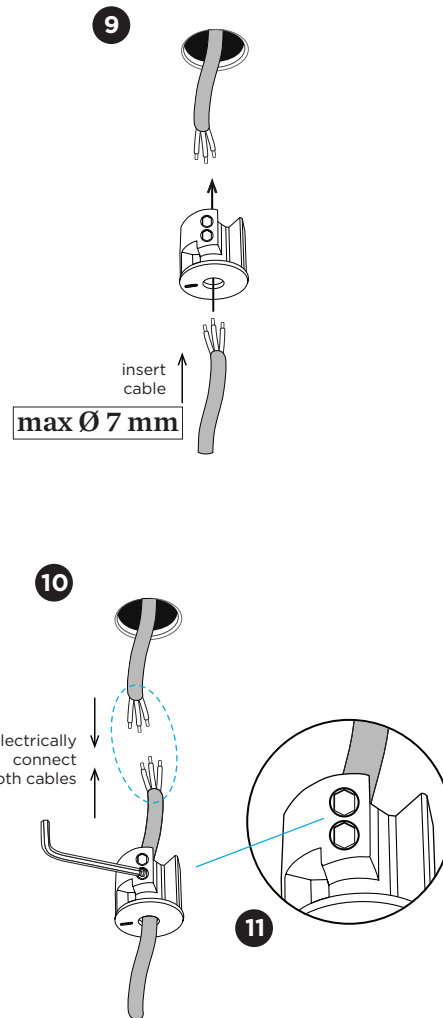
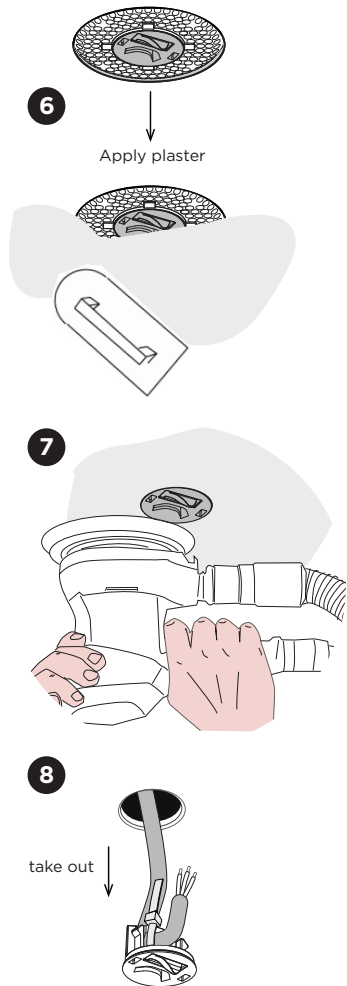

- 6 Apply plaster for a nice and smooth finish.
- 7 Grind the ceiling surface to make the cover comes visible again.
- 8 Take back out the protective cover and the supply line connected to this cover. Remove the cover.
- 9 Insert the luminaire cable through the hole of the inset as shown on the drawing
- 10 Electrically connect both power cable (from the luminaire) and the mains cable to each other.
- 11 Tighten both allen screws from the strain relief to firmly secure the power cable (as falling protection).
- 12 Insert the inset into the hole from the invisible ceiling system and turn it clockwise until secured.
- 13 Finish (in case no steel wire suspension cable is needed)

# INVISIBLE CEILING SUSPENSION SYSTEM

INSTALLATION INSTRUCTIONS | JULY 2020

Following steps are only needed for fixtures equipped with steel wire fixation

14

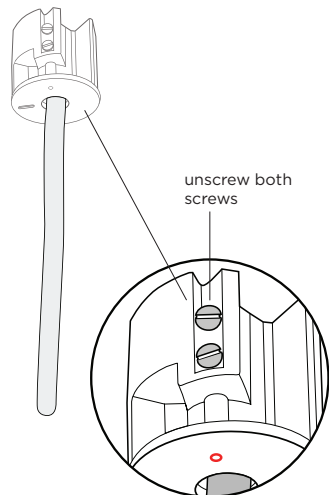

This side is to secure the strain relief with the inner allen screws

This side is to secure the steel wire suspension cable (if needed)

15

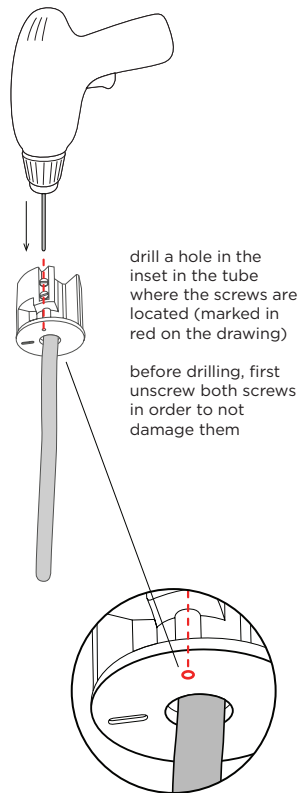

16

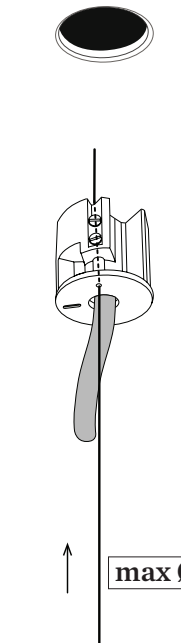

insert the steel wire into the hole (drilled) in the inset

tighten both screws firmly to secure the steel wire safely

17

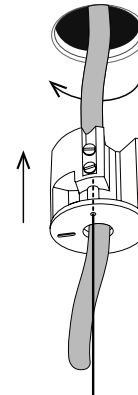

18

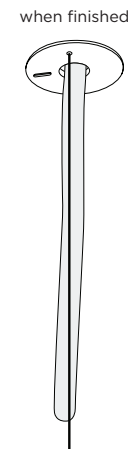

Following steps on this page are only needed for fixtures equipped with steel wire fixation.

14

Take the inset until you can see 2 metal screws at the side. Unscrew both screws.

15

Drill a hole from above, through the tube where the screws are located, through the plastic front cover

16

Insert the steel wire suspension cable through this hole and secure it by tightening both screws firmly. Now the steel wire cable is secured.

17

Insert the inset into the hole from the invisible ceiling system and turn it clockwise until secured.

18

Finish (in case steel wire suspension cable is used)